

**EDC Series Current Sensor
CurrentWatch Current Sensors**

Contents

Overview 1
 Model Selection,
 Switches 2
 Model Selection,
 Accessories 3
 Wiring Diagram 3
 Specifications 3
 Dimensions 4

The CurrentWatch EDC Series from Eaton’s electrical business combines a hall effect sensor and signal conditioner into a single package for use in DC current applications up to 300A. The EDC Series has jumper-selected current input ranges and industry standard outputs: 4 – 20 mA, 0 – 5V DC or 0 – 10V DC. Available in split-core models for quick and easy installation.

For typical applications of the CurrentWatch™ EDC Series, see listing to the right.

Approvals

- UL Listed (Pending)



Unless otherwise noted, the products contained in this document are not designed or intended for use in human safety applications.

Current Sensing for DC Loads up to 300A with Analog Outputs

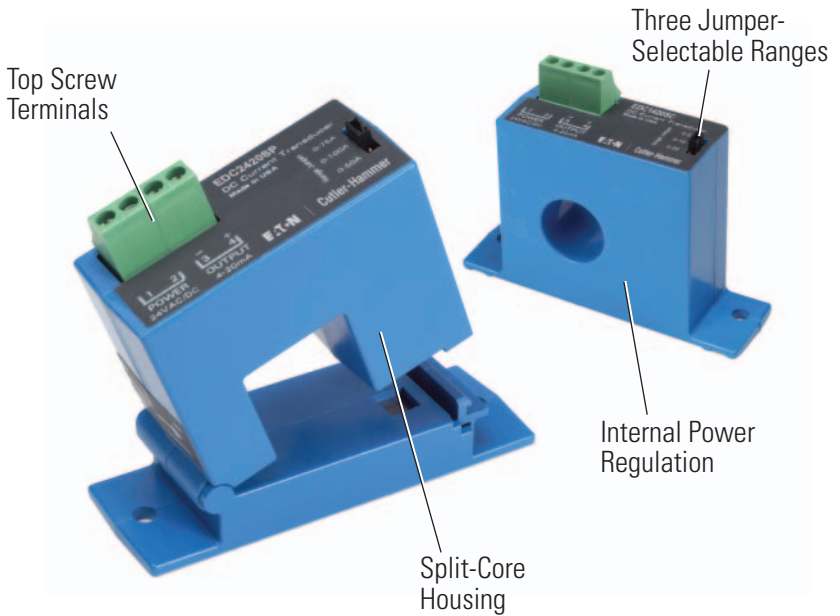

Product Features

- **Jumper-Selectable Ranges** — Reduces inventory and eliminates zero or span pots
- **Isolation** — Output is magnetically isolated from the input for safety, also eliminating insertion loss (voltage drop)
- **Internal Power Regulation** — Cuts installation costs and works well, even with unregulated power
- **Split Core Design and Built-In Mounting Brackets** — Makes installation quick and easy
- **UL and CE Approved**

Typical Applications

- **Battery Banks** — Monitors load current, monitors charging current and verifies operation
- **Transportation** — Measures traction power or auxiliary loads
- **Electric Heating Elements** — Monitors heater loads with a faster response time than temperature sensors



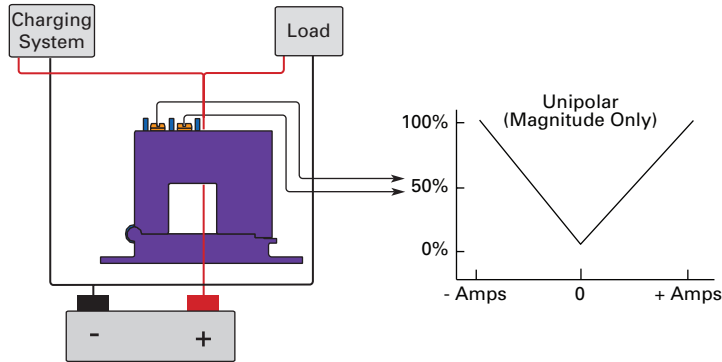

For Customer Service in the U.S. call **1-877-ETN CARE (386-2273)**,
 in Canada call **1-800-268-3578**.
 For Application Assistance in the U.S. and Canada
 call **1-800-426-9184**.

Example Application — CurrentWatch EDC Series

Battery Charging System

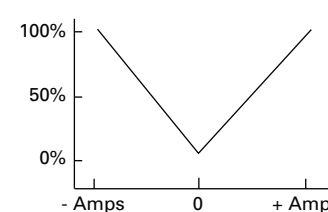

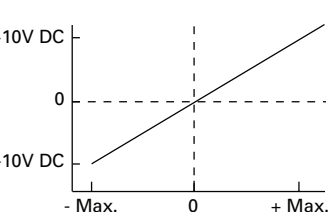
Model Selection — CurrentWatch EDC Series

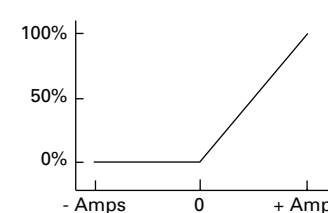
	Power Supply	Aperture Size	Output Graph	Output Signal	Current Range	Catalog Number	
Top Terminal Current Sensors							
Split-Core Housings 	24V AC/DC	0.85 in. (21.6 mm)		0 – 5V DC	50, 75 or 100A	EDC205SP	
					100, 150 or 200A	EDC305SP	
					150, 225 or 300A	EDC405SP	
					0 – 10V DC	50, 75 or 100A	EDC210SP
						100, 150 or 200A	EDC310SP
						150, 225 or 300A	EDC410SP
	4 – 20 mA	50, 75 or 100A	EDC2420SP				
		100, 150 or 200A	EDC3420SP				
		150, 225 or 300A	EDC4420SP				
Split-Core Housings 	24V AC/DC	0.85 in. (21.6 mm)		-10 – 10V DC	0 – 100A	EDCB100SP	
					0 – 200A	EDCB200SP	
					0 – 300A	EDCB300SP	
Solid-Core Housings 	24V AC/DC	0.75 in. (19 mm)		4 – 20 mA	5, 10 or 20A	EDC1420SC	

■ Stocked product, typical order quantities guaranteed in stock.

September 2009

Accessories — CurrentWatch EDC Series

	Description	Catalog Number
	DIN Rail Mounting Kit (Sensor pictured for reference and not included in kit)	EDINKIT

Stocked product, typical order quantities guaranteed in stock.

Wiring Diagram — CurrentWatch EDC Series

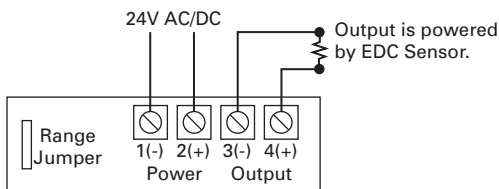

Specifications — CurrentWatch EDC Series

Description	Models with 0 – 5V DC Output	Models with 0 – 10V DC Output	Models with 4 – 20 mA Output
Power Supply	24V AC/DC (22 – 38V AC/DC) 2 VA Max.		
Output Signal	0 – 5V DC	0 – 10V DC	4 – 20 mA
Output Limit	5.75V DC	11.5V DC	23 mA
Accuracy	Solid-Core Models: 1% FS Split-Core Models: 2% FS 300A Models: 1.5% FS		
Response Time	Solid-Core Models: 20 mS (to 90% of step change) Split-Core Models: 100 mS (to 90% of step change)		
Frequency Range	DC		
Loading	25 kΩ min.	50 kΩ min.	650Ω max.
Isolation Voltage	3 kV (monitored line to output)		
Linearity	0.75% FS		
Current Ranges	Field selectable ranges from 0 – 300A		
Sensing Aperture	Solid-Core Housings: 0.75 in. (19 mm) dia. Split-Core Housings: 0.85 in. (21.6 mm) sq.		
Environmental	Operating Temperature: -4 to 122°F (-20 to 50°C) Humidity: 0 – 95% RH, Non-condensing		
Approvals	UL 508 Industrial Control Equipment (Pending, USA and Canada), CE Certified		

Approximate Dimensions — CurrentWatch EDC Series

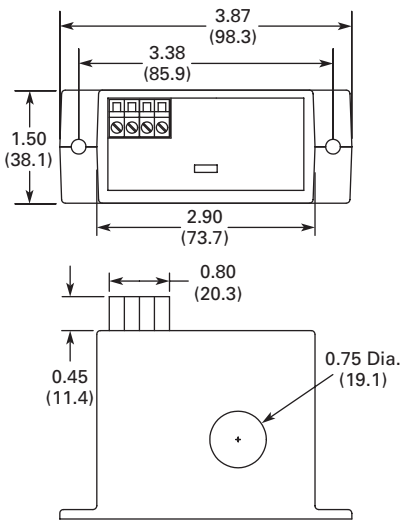
Description	Approximate Dimensions in Inches (mm)
Solid-Core Housings	
Split-Core Housings	